

RECOMMENDED TOOLS

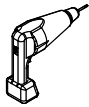

CRESCENT WRENCH



DRILL

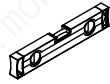

LEVEL RULER



UTILITY KNIFE



HOLE SAW

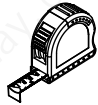

MEASURING TAPE



SQUARE



PENCIL



SAFETY GLASSES

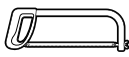

HACKSAW



SILICONE ADHESIVE SEALANT



CAULKING GUN

Vertical outlet Drain

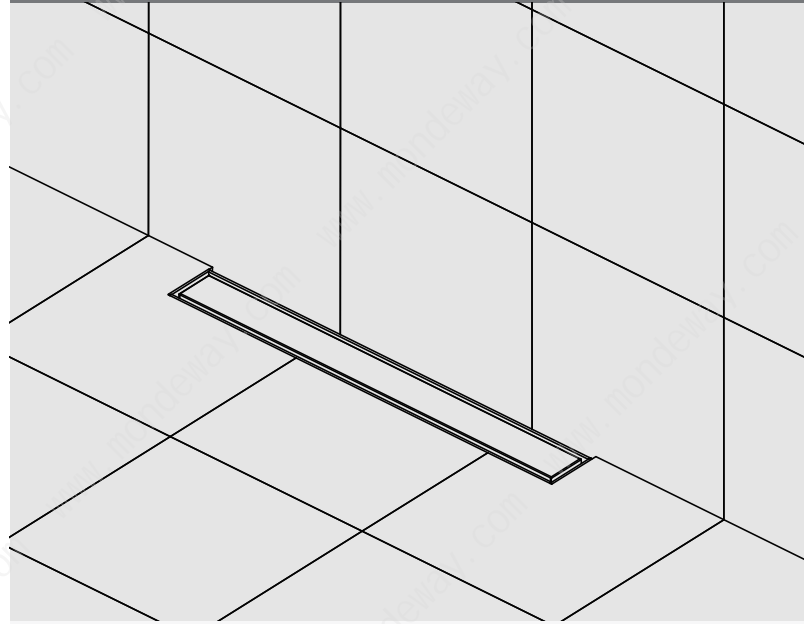

- Linear Drain
- Square Drain
- Shower Drain Base

WARNING!

Please check the product before installing it as to ensure that it is not damaged. Damaged products should not be built in.

INSTALLATION GUIDE

Installation overview–Linear Drain

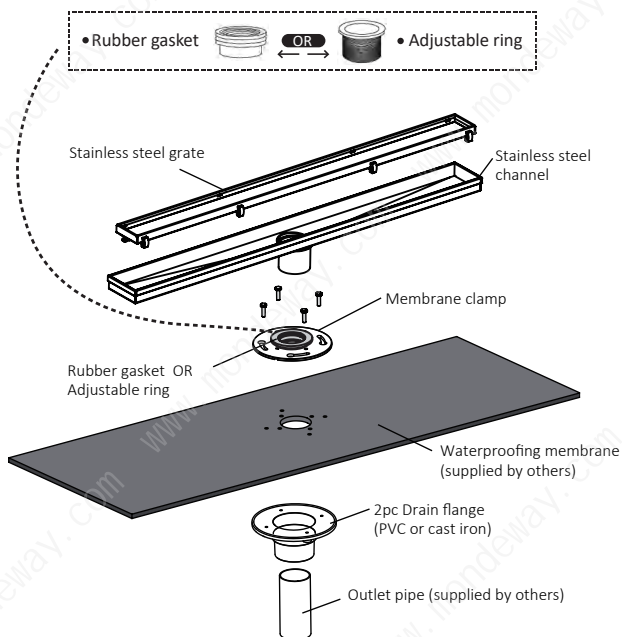

- Tiled showers rely on waterproofing membrane beneath the tiles and grout. Mondeway offers a number of options to ensure compatibility with different floor structures.
- The installation details shown set out to provide the designer with integrated solutions to wet room floor drainage identifying preparation, installation and construction processes required to install waterproof channels and floor drains in level threshold wet room environments.

Installation overview–Square Drain

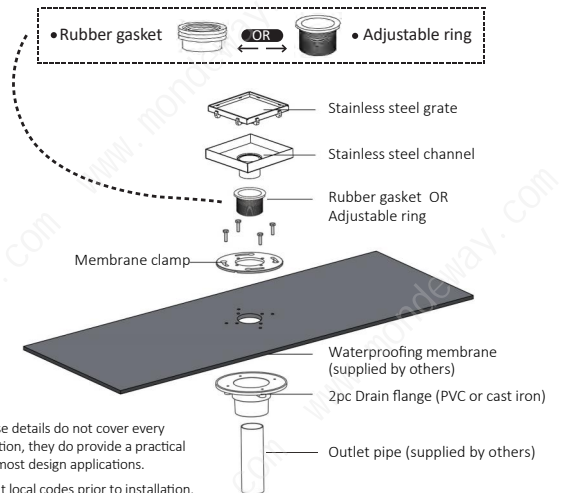

- Although these details do not cover every possible situation, they do provide a practical reference to most design applications.
- Always consult local codes prior to installation.

Installation layered diagram

1. Where alterations to floor joists are necessary, consult Structural Engineer for advice and reinforce floor joists as advised.
2. Frame out shower surround as required.
3. Connect base of flange outlet adaptor (1) to pipe work, leaving drain bolts in place. Block drain opening with rag to prevent floor mortar from blocking pipe work.
4. Trowel mortar onto sub-floor (2).
5. Install waterproofing membrane (3), reinforce around outlet and cut carefully to reveal heads of drain bolts and outlet.
6. Install top section of flange outlet adaptor (4).
7. Test membrane for leaks.
8. Lubricate outlet spigot on shower channel (liquid soap) and push fit shower channel into outlet at correct position and height.
9. Cut plastic installation feet to height to rest on the membrane and keep shower channel at required height and level.
10. Trowel mortar to required height (5), allowing for thickness of tile and thin set mortar and grade to create 2% slope towards the drain.
11. After floor mortar has cured, apply thin set (6) and install tile and grout (7).
12. Install grate into shower channel.

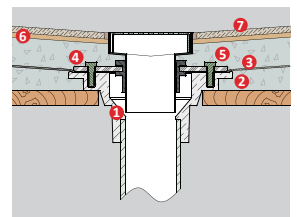

Installation Instruction

Step1:



Cut a tapered hole into the floor. Make sure the area under the floor is clear for plumbing. Notice 2x6 boards between studs will surround the shower walls.

Step2:



Base Flange of the drain into the hole with 4 wood screws. The top surface of the drain base should be flush with the top of the wood floor.

Step3:

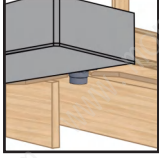

Lay rubber liner into shower area. Fold/tuck the vertical corners without cutting. Extend up the wall 6" and nail.

Step4:

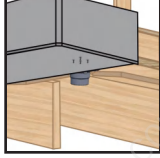

Using a sharp utility knife, cut a small slice into the rubber above the 4 holes where the 4 bolts will thread into. Push the bolts thru each slice and thread into drain base a few turns. In the center of the drain, slice an "X" into the rubber, no wider than about 2 inches.

Step5:



Place the clamping ring over the flange tighten with bolts. This will push the rubber liner in the center.

Step6:



Depending if you are going to use the rubber gasket or adjustable ring, you will either thread in the adjustable version or put in the rubber coupling. Shown pic is the adjustable ring. They are not meant to be used together. One or the other.

Step7:



Before the shower drain is installed on the flange, use a silicone ring to fix and then install it into the flange.

Step8:

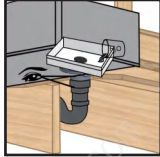

Align with the level of shower drain and connect the siphon with adapter to the outlet. After the connection is completed, check the siphon and drain are sealed tightly.

Step9:

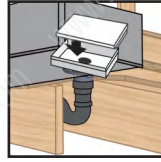

Before the installation of the shower drain, construction protection materials (such as polystyrene piece, available in the package) should be placed.

Step10:

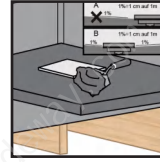

Floor pavement positioning with a 1% gradient.
Installation variation
A: ONE SIDED GRADIENT.
Floor pavement positioning with a 1% gradient.
Installation variation.
B: TWO SIDED GRADIENT.
When mortar layer is dry, perform necessary waterproofing (PVC Liner, Rubber Liner, Lead Pan, Copper Pan, Hot Mop, Fiberglass) as per local code. Ensure waterproofing layer reaches the edge of the hole in the drain body.

Step11:

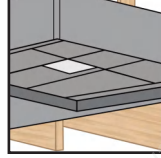

Place it with a suitable tile adhesive or other similar cover.

Step12:

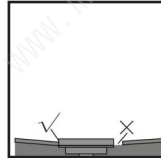

The floor cover must be placed accurately and attached to the material.

Step13:



Remove the protective material and clean the residue at the bottom.

Step14:

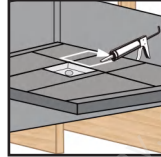

The floor and shower drain must be filled with adhesive.

Step15:



Embedded a stainless steel cover.

Installation Location

Drainage options

Installation against the wall	Walk-in: installation against the wall	Installation at shower entrance
<p>Simplest slope solution in one direction—slope away from the bathroom—no risk of bypass—use of waterproofing membrane is recommended.</p>	<p>Simplest slope solution in one direction—slope away from the bathroom—no risk of bypass—use of waterproofing membrane is recommended.</p>	<p>Slope in one direction, towards the bathroom—possible risk of bypass—slope of bathroom floor towards shower area is recommended to prevent bypass. Channel length should exactly fit the shower opening.</p>
<p>Two directional slope towards the bathroom. Channel length should exactly fit the shower opening.</p>	<p>Two directional slope towards the channel. Channel length should exactly fit the shower opening.</p>	<p>Use square drain within shower area. Floors must be graded up to 2% or other barriers must be used to prevent flow of water into bathroom area.</p>

CAUTION!

Cement grout film removers often contain aggressive chemicals. They can damage the surface of the recessed holder. Please be sure to rinse the drain thoroughly after using tile and joint cleaners. Do not use abrasives and/or sharp/scraping objects to clean the drain. Do not place corrosive products, such as steel or aluminium (spray) cans, directly on the stainless steel.

Care & Maintenance

After installation, some aggressive substances such as sealant, adhesive, mortar may cause "yellow spot" or grow in the surface structure and form unsightly "pools", and damage the surface.

- Periodically clean the fixture with warm water, a soft microfiber cloth, and (if necessary) soap.
- Rinse and scrub the fixture with warm water only. Avoid hard water or high mineral content water.
- Remove the material left after finishing, adhesive or mortar residue, if there is any. Clean the surface and accessories thoroughly and carefully.
- To reduce the chance of scratching, take care to wipe in the direction of the grain (direction of striations).
- Do not use abrasive cleaners, rubbing alcohol, detergents, chlorine bleach-based cleaners, aggressive chemicals, abrasive cleaning pad, or harsh polishes on the surface. Use of such substance may void the warranty.
- If you are using a chlorine bleach-containing cleaner in your shower, make sure that you avoid the holder surface and promptly remove any residue that may end up on the surface.



Acidic Cleaners



Bleach



Strong Cleaners



NO Abrasive Tools

Prohibited: Acidic cleaners, bleach, strong cleaners, brushes
Only use soft cleaning pads and brooms to clean the surface of the product.